

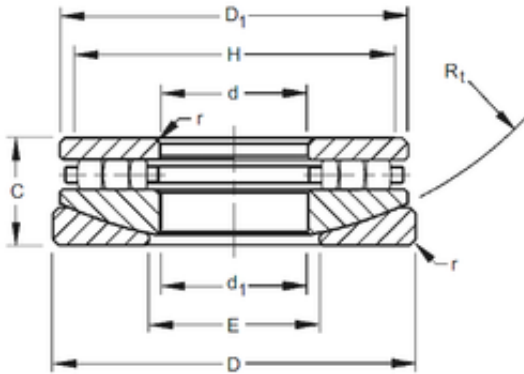

Timken 30TPS108 thrust roller bearings



Bearing No. 30TPS108

Bore Diameter	76,2 mm
Outer Diameter	211,125 mm
d	76,2 mm
D	211,125 mm
r max	1,6 mm
d1	77,79 mm
C	46,038 mm
D1	201,61 mm
E	133,4 mm
H	188,9 mm
R	304,8 mm

30TPS108 Bearing 2D drawings and 3D CAD models