

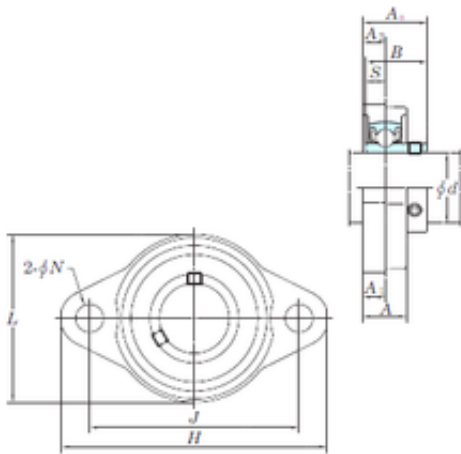

KOYO UFL004 bearing units



Bearing No. UFL004

Bore Diameter	20 mm
d	20 mm
A0	22 mm
A	16 mm
A1	8 mm
B	21 mm
H	90 mm
J	71 mm
L	55 mm
N	10 mm
S	7 mm
Bolt (G)	M8
A2	8 mm
Weight	0,18 Kg
Basic dynamic load rating (C)	9,4 kN
Basic static load rating (C0)	5,05 kN
Bearing No.	UFL004
Bolt size	M8
Cr	9.40
C0r	5.05
f0	13.9
(Refer.) Unit mass(kg)	0.18

UFL004 Bearing 2D drawings and 3D CAD models